

Locally Manufactured

High Quality

Competitive Pricing



Specialty Steel Inc. Stainless Steel Casework Guide

Residential - Industrial - Food & Beverage - Healthcare - Education - Marine
Regardless of industry, Specialty Steel provides top quality stainless steel cabinets and countertops to satisfy the needs of our customers.





About Us



Who Are We?

Specialty Steel is a family owned business that values customer satisfaction above all. At Specialty Steel Inc., we specialize in custom stainless steel, aluminum and metal products. Our team of professionals is committed to delivering high quality products at fair prices, with timely delivery schedules that meet or exceed our customer's needs. With over 40 years of experience in the industry, we have built a reputation for excellence and quality that sets us apart from the competition.

Licensed, Insured & Certified

Specialty Steel Inc. is fully licensed and insured, giving our customers peace of mind knowing that they are working with a reputable and trustworthy company. Our welders are CWB certified to meet the required specifications for your projects.

Personalized Approach

At Specialty Steel Inc., we take a personalized approach to every project we work on. Our team works closely with our customers to understand their unique needs and specifications, ensuring that we deliver a quality product that exceeds our customer's needs.





Stainless Caework Overview

Why Stainless Steel?

Stainless steel is a strong metal that is resistant to corrosion, moisture, fire and variations in temperature. Stainless steel cabinetry and countertops can withstand harsh environments in comparison to other commonly used materials. Their smooth surface is very easy to keep clean and is therefore very sanitary. Stainless steel also has a sleek look, is very esthetically pleasing and will compliment any design. These cabinets and countertops are frequently used in many residential, commercial and industrial spaces.

The Fabrication Process

All of our stainless-steel cabinetry and countertops are fabricated in our shop right here in Debert, Nova Scotia. Grade 304 stainless steel with a brushed #4 finish is typically used for fabrication however, if there is a need for greater corrosion resistance, grade 316 can be substituted. This may be required in high saline environments such as marine industry and some healthcare applications. The fabrication process starts with plans (architectural drawings, hand sketches, dimensions) from our customer. Our qualified Solidworks designers then provide shop drawings to the customer to be approved. Once approved, the parts are programmed and cut on our 2-dimensional laser cutter, bent on our CNC brake and assembled through the use of stainless-steel rivets and welding. With our high precision laser cutter and CNC brake, we can ensure proper sizing of all finished products.

Sizing Options

This catalogue provides customers with information on our stock cabinetry sizes and styles to chose from. Specialty Steel can also fabricate custom cabinetry and cabinets to the specifications provided by our customers. If you don't see what you are looking for in this guide, or if you require a different size, contact us and we will be happy to assist you in making your vision a reality.





Typical Cabinet Design

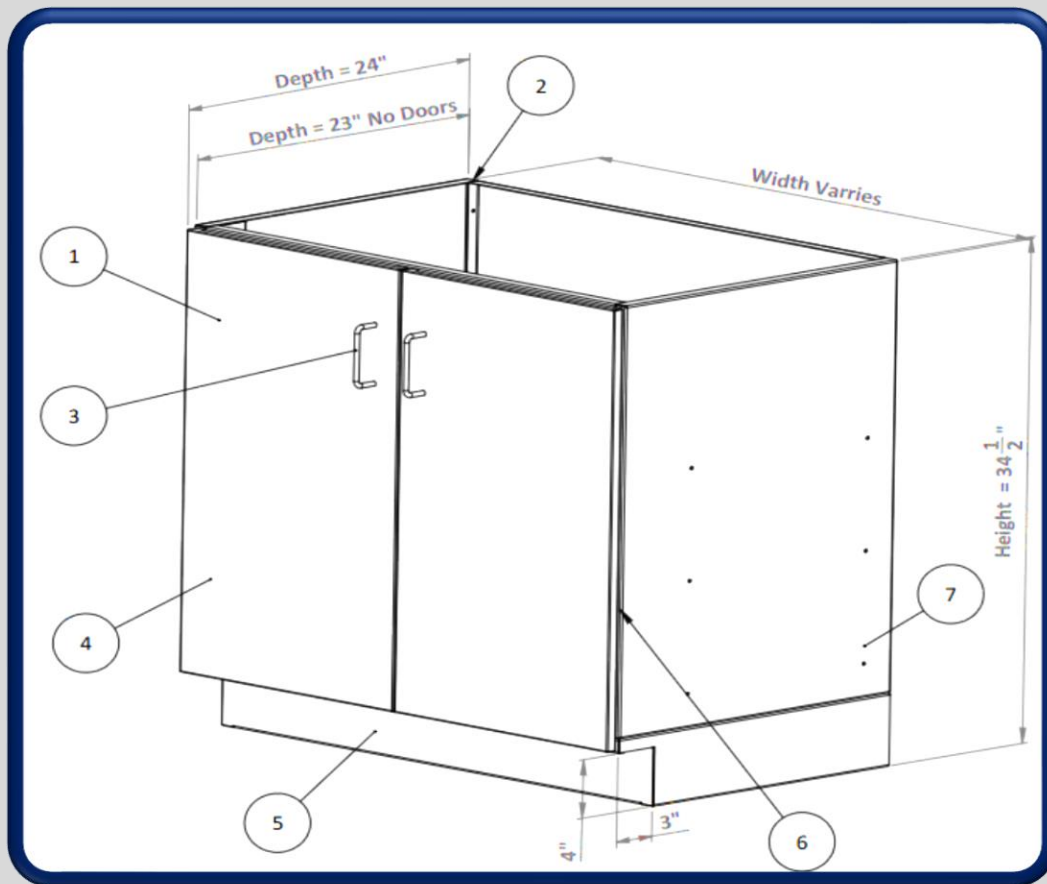





- 1 Fabricated from 304 or 316 Brushed Stainless Steel
- 2 All Corners Welded and Polished for Strength and Longevity
- 3 Polished Stainless Steel Door Pulls
- 4 Double Layered Door for Added Rigidity and Strength
- 5 4" Toe Kick
- 6 Concealed Hinged for a Sleek Design
- 7 Adjustable Shelves (Adjustable every 1")

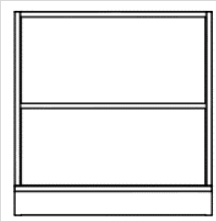
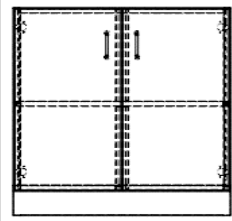
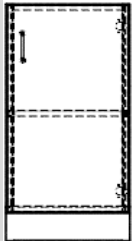
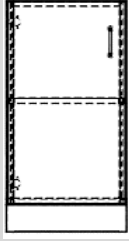

Base Cabinet Styles and Sizes

All standard base cabinets are completed with a 4" toekick and are equipped with an adjustable shelf. See sizing details below.

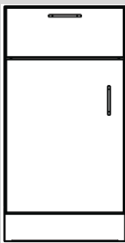
Base Cabinet Standards	
Height =	30 1/2in
Depth =	24in
	23in (No Doors)

Open Cabinet	Width (in)	Double Cabinet	Width (in)
	12		24
	16		30
	24		36
	30		48
	36		
	48		
Single RH Cabinet	Width (in)	Single LH Cabinet	Width (in)
	12		12
	16		16
	24		24
Combination Double Cabinet	Width (in)	Combination RH Cabinet	Width (in)
	24		16
	30		24
	36		
	48		
Combination LH Cabinet	Width (in)	4 Drawer Bank	Width (in)
	16		16
	24		24



Locally Manufactured

High Quality

Competitive Pricing

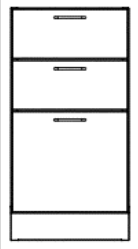
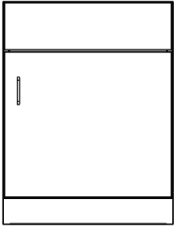
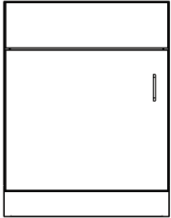
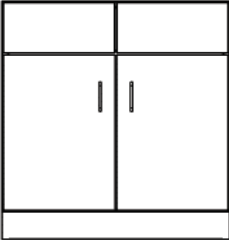
3 Drawer Bank	Width (in)	Single Sink RH Cabinet	Width (in)
	16		24
	24		
Single Sink LH Cabinet	Width (in)	Double Sink Cabinet	Width (in)
	24		24
			30
			36
			48

Our Work









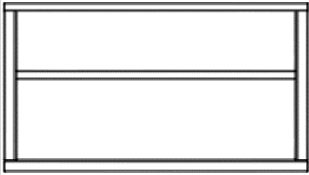

Upper Cabinet Styles and Sizes

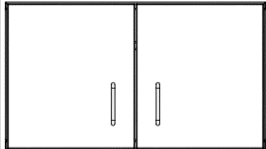
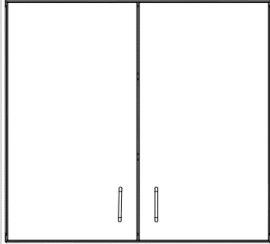
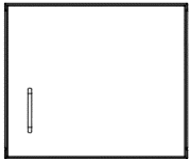
All standard upper cabinets include 1 or 2 adjustable shelves depending on height and can be equipped with glass doors. See sizing details below.

Upper Cabinet Standards	
Height =	Varries
Depth =	12in (With Doors) 11 in (No Doors)

Short Open Cabinet	Height (in)	Width (in)	Tall Open Cabinet	Height (in)	Width (in)
	15	12		30	12
	15	16		30	16
	15	24		30	24
	15	30		30	30
	15	36		30	36
Short Double Cabinet	Height (in)	Width (in)	Tall Double Cabinet	Height (in)	Width (in)
	15	24		30	24
	15	30		30	30
	15	36		30	36
Short Single RH Cabinet	Height (in)	Width (in)	Tall Single RH Cabinet	Height (in)	Width (in)
	15	12		30	12
	15	16		30	16
Short Single LH Cabinet	Height (in)	Width (in)	Tall Single LH Cabinet	Height (in)	Width (in)
	15	12		30	12
	15	16		30	16
				30	24
				30	30
				30	36





Countertop Styles

Countertops can be made to fit individual cabinets or rows of cabinets and be equipped with a sink (see sink options on next page). In some cases, countertops are adhered to customer supplied wood substrate sized to fit the exact site conditions. In some healthcare applications, where a wood substrate is unacceptable, countertops can be fabricated with a stainless frame for enhanced strength and rigidity. See design details below.

<p>Straight Edge No Backsplash</p>	
<p>Straight Edge With 4" Backsplash</p>	
<p>Marine Edge No Backsplash</p>	
<p>Marine Edge With 4" Backsplash</p>	





Sink Styles

Countertops can be equipped with a sink. Below shows the different types of sink styles.

Drop in Sink



Undermount Sink



Integrated Weld in Sink





Ordering Process

Send an email, give us a call or stop in to discuss your project.

We look forward to doing business with you!

Office Address

497 MacElmon Rd
Debert, NS

Call Us

(902) 662-3069

Email Contact List

Steve Ehrhardt	Lead Estimator	sehrhardt@specialtysteelinc.com
Mike MacDonald	Estimator	mmacdonald@specialtysteelinc.com
Marlee Davis	Project Manager	mdavis@specialtysteelinc.com

